

Service
Service
Service



Service Manual

TABLE OF CONTENTS

	Chapter
Technical Specification & Service Tips.....	1
Safety Instructions.....	2
Instruction for Use.....	3
Mechanical Instructions.....	4
Troubleshooting	5
Overall Block Diagram.....	6
Overall Wiring Diagram.....	7
Electrical Diagram.....	8
Component Layout.....	9
Service Part List.....	10
Revision List.....	11

©Copyright 2005 Philips Consumer Electronics B.V. Eindhoven, The Netherlands
All rights reserved. No part of this publication may be reproduced, stored in a
retrieval system or transmitted, in any form or by any means, electronics,
mechanical, photocopying, or otherwise without the prior permission of Philips

3141 785 31733

1.0 TECHNICAL SPECIFICATION

Document Type: Symptom Cure Document BG-ES

Reference Number: PI-07/027

Problem type: General

Problem area: General

Symptom:

PET1030 - Set exchange of units come in a selected range of production serial number

Cure:

For any return of PET1030 which comes in the following ranges of production serial number of the corresponding stroke versions

PET1030/00 LL1B0719002306 - LL1B0724008506
PET1030/37 LL1A0719000005 - LL1A0724006784
PET1030/05 LL1B0716000506 - LL1B0720001006
PET1030/58 LL1A0721000010 - LL1A0721002109
PET1030/98 LL1A0723000005 - LL1A0723000304
PET1030/93 LL1A0723000005 - LL1A0723000505

will need to be exchanged with a new units of production serial number of the followings or onwards.

PET1030/00 LL1B0725008507
PET1030/37 LL1A0724006785
PET1030/05 LL1B0724001007
PET1030/58 LL1A0724002110
PET1030/98 LL1A0724000305
PET1030/93 LL1A0728000506

EXCHANGED SETS NEED TO BE COLLECTED FOR FURTHER NOTICE. ADDITIONAL INSTRUCTIONS WILL BE GIVEN BY THE NATIONAL SERVICE ORGANIZATION SHORTLY!

Take care that these sets are claimed with IRIS repair code Z6

IRIS code: X XXX X Z6

Product Model/Chassis:

PET1030/00
PET1030/05
PET1030/37
PET1030/58
PET1030/93
PET1030/98

1.0 TECHNICAL SPECIFICATION

General

Dimensions (W x H x D):	204 x 168 x 33 mm
Weight:	1.0kg
Power supply:	DC 9V 1.8A
Power consumption:	20W
Operating temp. & RH:	0 - 50 degC / 30 – 90% RH
Laser wavelength:	650nm
Video system	NTSC / PAL / AUTO
Dynamic range:	>/=80dB
Signal/Noise ratio:	>/=85dB
Frequency response	20Hz-20kHz +/-1dB
Channel Separation 1kHz	>/=85dB
Channel Balance 1kHz	1dB
Audio out (analog audio)	Output level: 2V +/- 10%
Load impedance:	10Kohm
Video out Output level	1Vp – p +/- 20%
Load impedance	75ohm

Playback disc type:	DVD, Picture-CD, SVCD, Video CD, MP3-CD, CD-R/CD-RW, WMA-CD, DVD-R, DVD-RW, DVD+R, DVD+RW
Video Playback Format:	DVD / VCD / JPEG
Audio Playback Format:	CD/MP3, MP3-DVD, WMA
Disc Diameter	12cm

Pixel specification

Zero bright-dot & max. 3 dark-dots

Current consumption

DC-IN SUPPLY (9V)	
Battery Charging Current	1.2A typical
BATT. SUPPLY (7.2V)	
Power Off	0A
Playback with TFT on	<1.2A typical
Playback without TFT on	<600mA
Battery time (playback)	>2.5 hour

Headphone out (headphone output load 2x16 ohm)

Maximum output power:	>10mW
Frequency response:	20Hz – 20kHz
SNR (A-wght):	80dB typical
THD (0.2-20kHz):	<1%
Left-Right Channel	32dB
Separation:	
Left-Right Channel	1dB
Balance:	

Supported disc type

Video Playback Formats:



Audio Playback Formats:



1.0 TECHNICAL SPECIFICATION

Factory Service Mode (FSM)

Procedure to check the software version of your portable DVD Player

1. Press [SETUP] to enter the setup Menu
2. Press [RETURN] and then press "1" -> "2" -> "3" by remote control
3. The display will show the software version as the date of which the software was built on the bottom of the screen.

Procedure to upgrade the software of your portable DVD Portable

For the best performance of your DVD Portable. Check www.philips.com/support for latest software upgrades available.

1. Download the latest software from the Philips support site
2. Unzip the files and then burn it into a CD-ROM to make a disc for upgrade
3. Power on the Portable DVD Player with AC/DC adaptor
4. Play CD-ROM for firmware upgrade

Warning: Do not unplug the AC adaptor during firmware upgrade to prevent flash corrupt of the set!!

5. Once upgrade is completed, the player is reset automatically
6. Open the DVD door to remove the disc

Procedure to change region code of your portable DVD player

1. Power on player and open the DVD door
2. Press [SETUP] by remote control.
3. In Set Up Menu, select <Audio> and press [OK]
4. Press [2], [1], [2], [2], [2], [5], [<], [V]
5. Display will show the Region Code
6. Press Number Key button by remote control to select the region code
7. Refer below table for your region code setting

Region Code	Region
1	USA
2	EUROPE
3	ASIA PACIFIC
4	AUSTRALIA, NEW ZEALAND, LATAM
5	RUSSIA, INDIA
6	CHINA

Region code "0" can be used for all regions!

8. Press [SETUP] to save and exit your setting
9. Power off and power on again to verify if region code change is done

Remarks:

1. **Password is CONFIDENTIAL**
2. **Region code is printed on product type plate. Due to DVD legislation region codes different to assigned region may not be released**

2.0 SAFETY INSTRUCTIONS

GB WARNING

All ICs and many other semi-conductors are susceptible to electrostatic discharges (ESD). Careless handling during repair can reduce life drastically. When repairing, make sure that you are connected with the same potential as the mass of the set via a wrist wrap with resistance. Keep components and tools also at this potential.

F ATTENTION

Tous les IC et beaucoup d'autres semi-conducteurs sont sensibles aux décharges statiques (ESD). Leur longévité pourrait être considérablement écourtée par le fait qu'aucune précaution n'est prise à leur manipulation. Lors de réparations, s'assurer de bien être relié au même potentiel que la masse de l'appareil et enfilez le bracelet serti d'une résistance de sécurité. Veiller à ce que les composants ainsi que les outils que l'on utilise soient également à ce potentiel.

D WARNUNG

Alle ICs und viele andere Halbleiter sind empfindlich gegenüber elektrostatischen Entladungen (ESD). Unsorgfältige Behandlung im Reparaturfall kann die Lebensdauer drastisch reduzieren. Veranlassen Sie, dass Sie im Reparaturfall über ein Pulsarmband mit Widerstand verbunden sind mit dem gleichen Potential wie die Masse des Gerätes. Bauteile und Hilfsmittel auch auf dieses gleiche Potential halten.

ESD



NL WAARSCHUWING

Alle IC's en vele andere halfgeleiders zijn gevoelig voor electrostatische ontladingen (ESD). Onzorgvuldig behandelen tijdens reparatie kan de levensduur drastisch doen verminderen. Zorg ervoor dat u tijdens reparatie via een polsband met weerstand verbonden bent met hetzelfde potentiaal als de massa van het apparaat. Houd componenten en hulpmiddelen ook op ditzelfde potentiaal.

I AVVERTIMENTO

Tutti IC e parecchi semi-conduttori sono sensibili alle scariche statiche (ESD). La loro longevità potrebbe essere fortemente ridotta in caso di non osservazione della più grande cauzione alla loro manipolazione. Durante le riparazioni occorre quindi essere collegato allo stesso potenziale che quello della massa dell'apparecchio tramite un braccialetto a resistenza. Assicurarsi che i componenti e anche gli utensili con quali si lavora siano anche a questo potenziale.

GB

Safety regulations require that the set be restored to its original condition and that parts which are identical with those specified, be used.

"Pour votre sécurité, ces documents doivent être utilisés par des spécialistes agréés, seuls habilités à réparer votre appareil en panne".

NL

Veiligheidsbepalingen vereisen, dat het apparaat bij reparatie in zijn oorspronkelijke toestand wordt teruggebracht en dat onderdelen, identiek aan de gespecificeerde, worden toegepast.

F

Les normes de sécurité exigent que l'appareil soit remis à l'état d'origine et que soient utilisés les pièces de rechange identiques à celles spécifiées.

D

Bei jeder Reparatur sind die geltenden Sicherheitsvorschriften zu beachten. Der Originalzustand des Geräts darf nicht verändert werden; für Reparaturen sind Original-Ersatzteile zu verwenden.

I

Le norme di sicurezza esigono che l'apparecchio venga rimesso nelle condizioni originali e che siano utilizzati i pezzi di ricambio identici a quelli specificati.

"After servicing and before returning set to customer perform a leakage current measurement test from all exposed metal parts to earth ground to assure no shock hazard exist. The leakage current must not exceed 0.5mA."



GB Warning !

Invisible laser radiation when open.
Avoid direct exposure to beam.

S Varning !

Osynlig laserstrålning när apparaten är öppnad och spärrar är urkopplad. Beträkta ej strålen.

SF Varoitus !

Avatussa laitteessa ja suojalukituksen ohitettaessa olet alltiina näkymättömälle laserisäteilylle. Älä katso säteeseen!

DK Advarse !

Usynlig laserstråling ved åbning når sikkerhedsafbrydere er ude af funktion. Undgå udsættelse for stråling.

2.1 ESD PROTECTION

- レンズには絶対に触れないでください。
- DO NOT TOUCH THE LENS.
- LINSE NICHT BRÜHREN.
- NE PAS TOUCHER LA LENTILLE.

When the power supply is being turned on, you may not remove this laser cautions label. If it removes, radiation of laser may be received.

PREPARATION OF SERVICING

Pickup Head consists of a laser diode that is very susceptible to external static electricity.

Although it operates properly after replacement, if it was subject to electrostatic discharge during replacement, its life might be shortened. When replacing, use a conductive mat, soldering iron with ground wire, etc. to protect the laser diode from damage by static electricity.

And also, the LSI and IC are same as above.

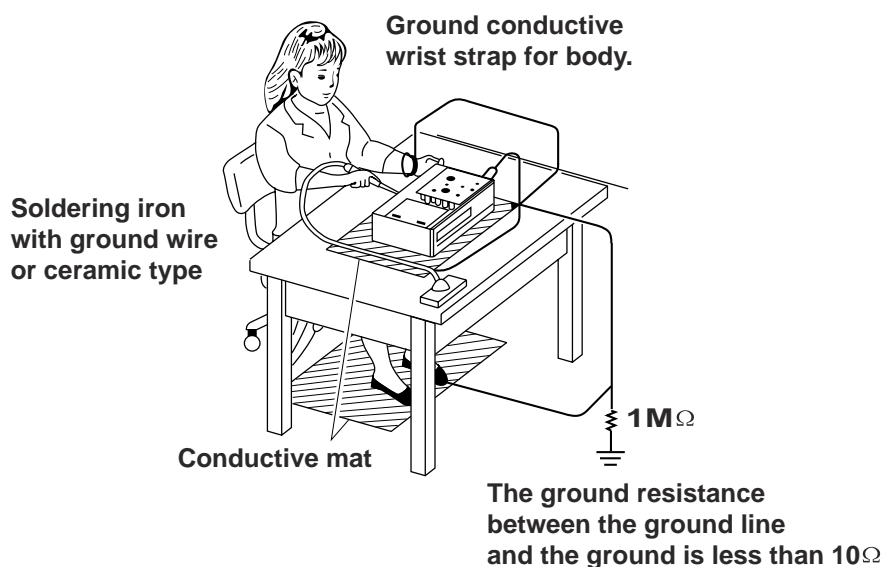

SAFTY NOTICE

SAFTY PRECAUTIONS

LEAKAGE CURRENT CHECK

Plug the AC line cord directly into a 120V AC outlet (do not use an isolation transformer for this check). Use an AC voltmeter, having 5000Ω per volt or more sensitivity. Connect a 1500Ω 10W resistor, paralleled by a $0.15\mu\text{F}$ 150V AC capacitor between a known good earth ground (water pipe, conduit, etc.) and all exposed metal parts of cabinet (antennas, handle bracket, metal cabinet screwheads, metal overlays, control shafts, etc.).

Measure the AC voltage across the 1500Ω resistor. The test must be conducted with the AC switch on and then repeated with the AC switch off. The AC voltage indicated by the meter may not exceed 0.3V. A reading exceeding 0.3V indicates that a dangerous potential exists, the fault must be located and corrected. Repeat the above test with the DVD VIDEO PLAYER power plug reversed. NEVER RETURN A DVD VIDEO PLAYER TO THE CUSTOMER WITHOUT TAKING NECESSARY CORRECTIVE ACTION.

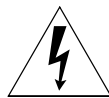
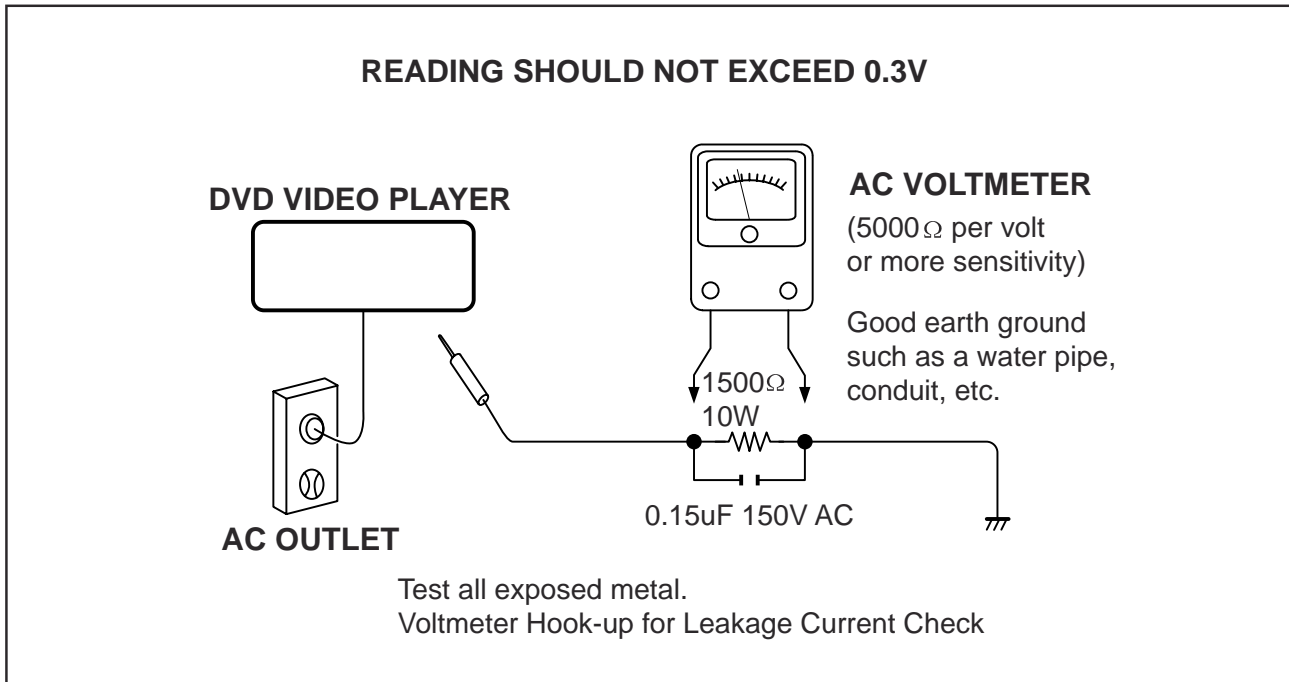

The lightning flash with arrowhead symbol, within an equilateral triangle, is intended to alert the user to the presence of uninsulated "dangerous voltage" within the product's enclosure that may be of sufficient magnitude to constitute a risk of electric shock to persons.



The exclamation point within an equilateral triangle is intended to alert the user to the presence of important operating and maintenance (servicing) instructions in the literature accompanying the appliance.

3.0 INSTRUCTIONS FOR USE

- | | |
|---|--|
| ① ▶
Start / pause / resume playback. | ⑫ POWER
Switches the player on / off. |
| ② ■
Press once to stop playback and store the stop position. Press twice to stop playback completely. | ⑬ CHR/IR/POWER
Power /remote sensor /charging indicator. |
| ③ ◀◀ / ▶▶
Search backward (◀◀) or search forward (▶▶). | ⑭ RESET
Reset the player when it is hanged up. |
| ④ - VOL +
Volume control. | ⑮ Car mounting screw hole |
| ⑤ SETUP
Enter SETUP menu. | ⑯ Headphones jack. |
| ⑥ DISPLAY
Adjust the display value of the system. | ⑰ AV OUT
Audio/video output jack. |
| ⑦ DISC MENU
Display MUNE page. | ⑱ AV IN
Audio/video input jack. |
| ⑧ ▲, ▼, ◀, ▶
Up / down / left / right cursor.
OK
Confirm seletion. | ⑲ USB
USB connector. |
| ⑨ OPTION
Access additional functions. | ⑳ SD•MMC•MS CARD
Insert SD/MMC CARD. |
| ⑩ CHR/IR/POWER
Power /remote sensor /charging indicator. | ㉑ COAXIAL
Digital Audio output jack. |
| ⑪ OPEN
Opens disc door to insert or remove disc. | ㉒ COMP.OUT/S VIDEO
Component / S video output. |
| | ㉓ DC IN 9V
Power supply socket. |

CAUTION

Use of controls or adjustments or performance of procedures other than herein may result in hazardous radiation exposure or other unsafe operation.

DVD PLAYER LAYOUT

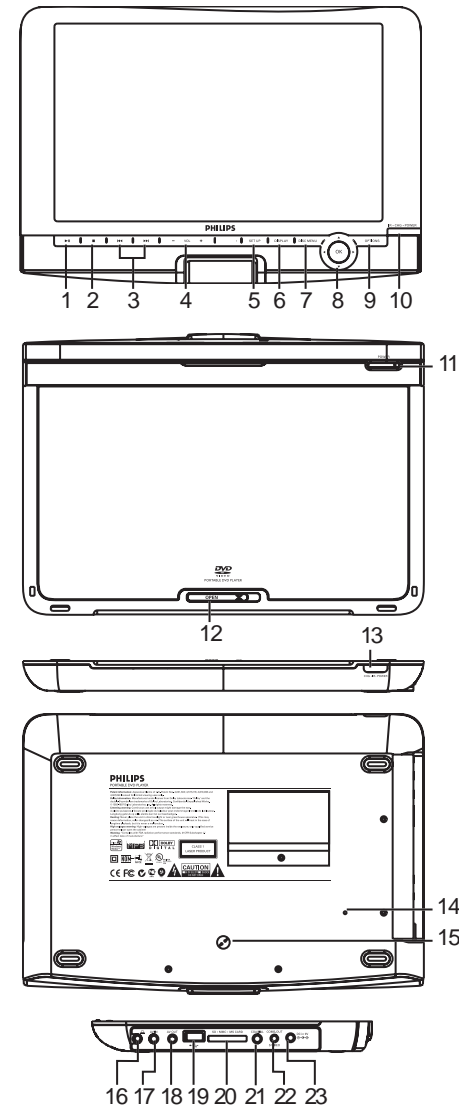

REMOTE CONTROL

- ① **MENU**
Display **MENU** page.
- ② ▲, ▼, ◀, ▶
Up / down / left / right navigation key.
- OK**
Confirm selection.
- VOL +/-**
Volume control.
- ③ **DISPLAY**
Adjust the display value of the system.
- ④ ⏮
Skip to previous chapter, track or title.
- ⑤ ▶⏸
Start / pause / resume playback
- ⑥ ■
Access additional functions.
- ⑦ **0 - 9**
Numeric keypad.
- ⑧ **SUBTITLE**
Subtitle language selector.
- ⑨ **RETURN**
For VCD menu page.
- ⑩ **A - B**
To repeat or loop a sequence in a title.
- ⑪ **SETUP**
Enter **SETUP** menu.
- ⑫ **OPTION**
Access additional functions.
- ⑬ ▶▶
Skip to next chapter, track or title.
- ⑭ 🔊
Mute player volume
- ⑮ **AUDIO**
Audio language selector.
- ⑯ **ZOOM**
Enlarge video image.

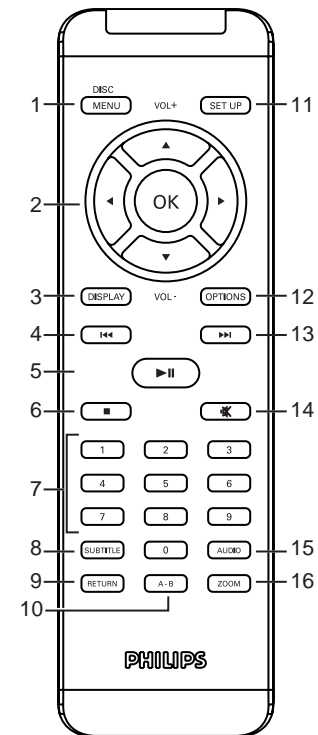

4.0 MECHNICAL INSTRUCTIONS

1. Side view as Fig.1

Remove base cover adorn discreteness as Fig.1.



Fig.1

2. Remove screws of the base cover as Fig.2.



Fig.2

3. Remove screws of the base cover as Fig.3

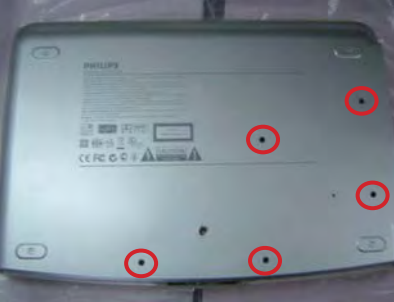

Fig.3

4. Open the door and remove screws to remove door & middle cabinet discreteness as Fig.4.



Fig.4

5. Rotate the top and remove screws to break the top and the base away as Fig.5.



Fig.5

6. Disconnect DVD driver from board, then soldered short pattern for laser diode as Fig.6.

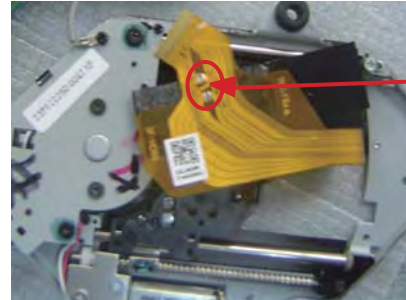

Fig.6

7. Remove screws to remove lithium battery and lithium battery protective pcb as Fig.7.

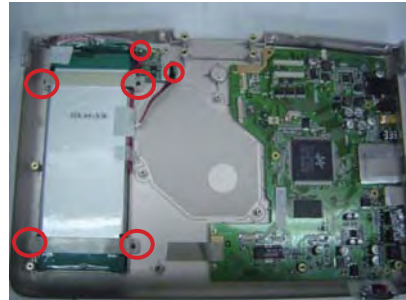

Fig.7

8. Remove screws to remove main board as Fig.8.



Fig.8

4.0 MECHNICAL INSTRUCTIONS

9. Remove speaker grill as Fig.9.



Fig.9

10. Remove screws to remove top cover discreteness as Fig.10.



Fig.10

11. Disconnection of IF board
Remove IF board and speaker as Fig.11.



Fig.11

12. Remove HV board as Fig.12.



Fig.12

13. Remove LCD TFT and function board as Fig.13.

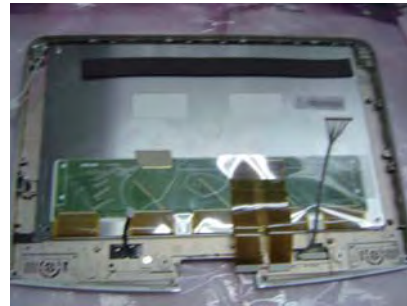
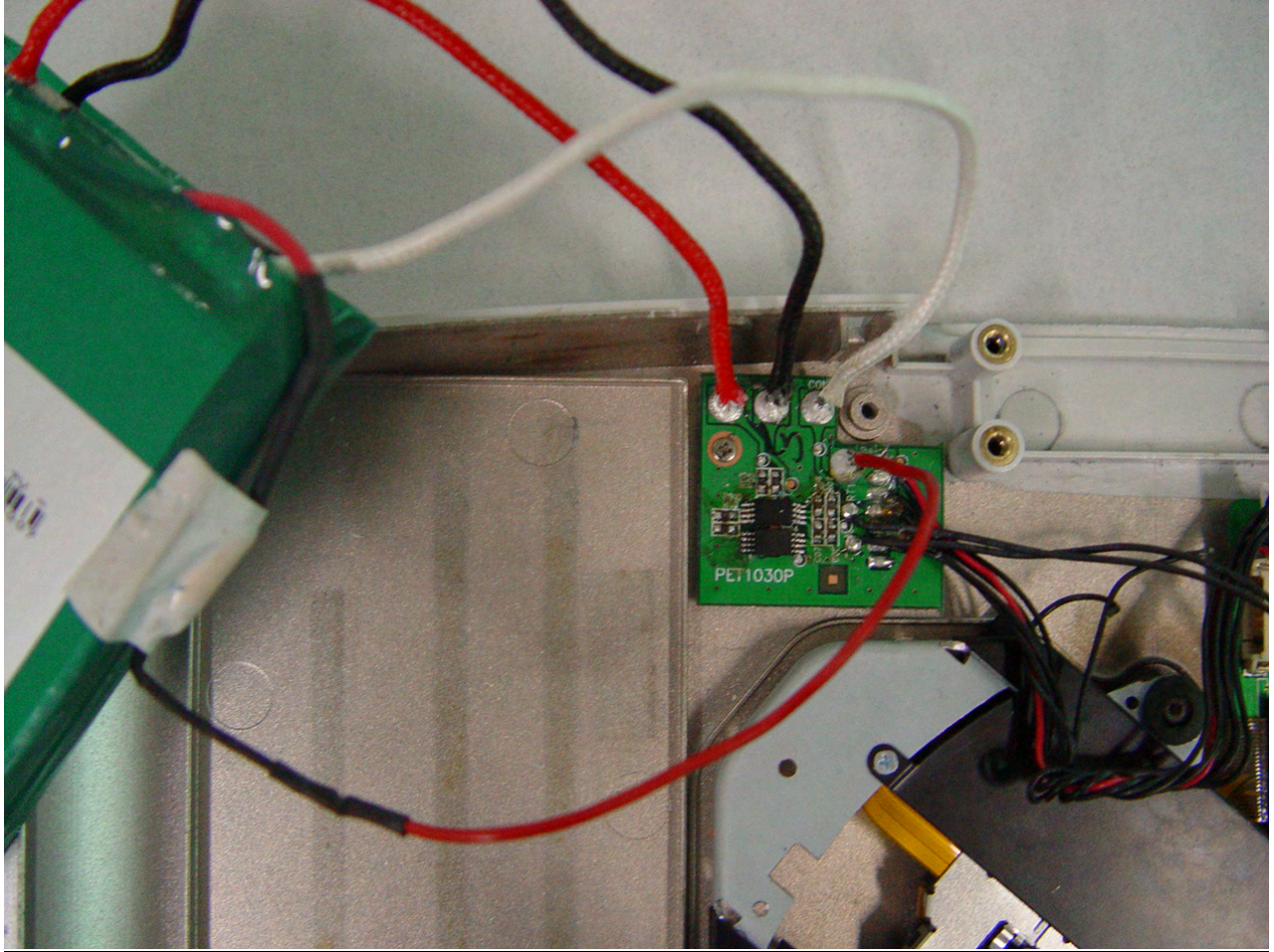

Fig.13

4.0 MECHANICAL INSTRUCTIONS

Close up on the connectivity of 996510006526 & 996510003961



5.0 TROUBLESHOOTING & SERVICE TIPS

SYMPTOM: NO POWER, NO GREEN LED

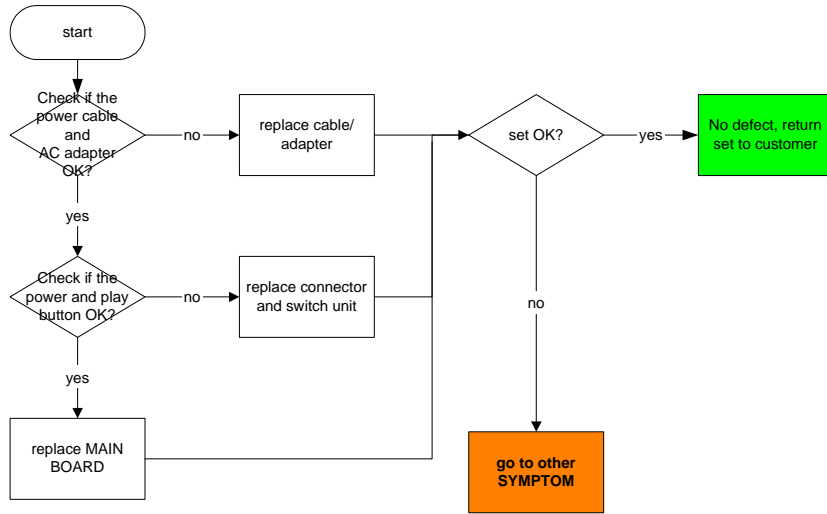

SYMPTOM: NO IMAGE OR SOUND COMES OUT FROM THE EXTERNAL OUTPUT

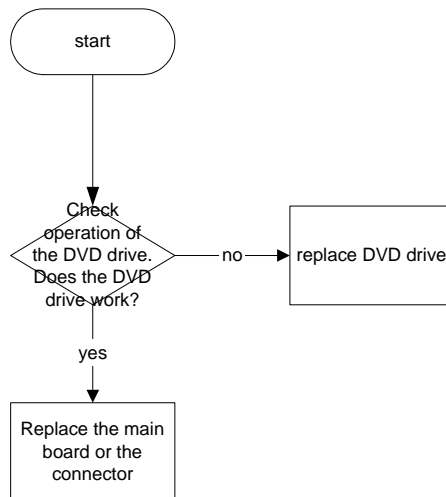

5.0 TROUBLESHOOTING & SERVICE TIPS

SYMPTOM: THE INITIAL SCREEN IS NOT DISPLAYED ON THE LCD

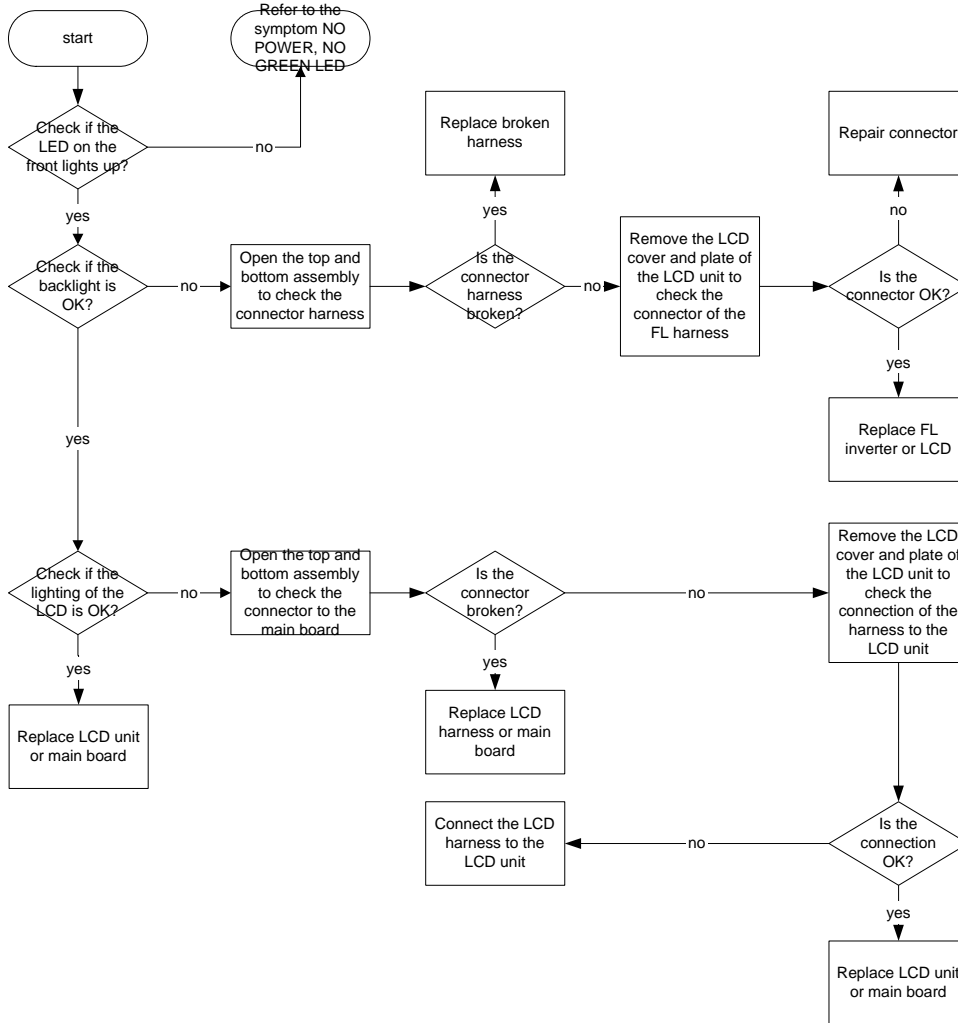

SYMPTOM: NO IMAGE OR SOUND COMES OUT FROM THE EXTERNAL INPUT

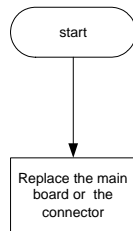

5.0 TROUBLESHOOTING & SERVICE TIPS

SYMPTOM: THE DVD DRIVE DOES NOT WORK

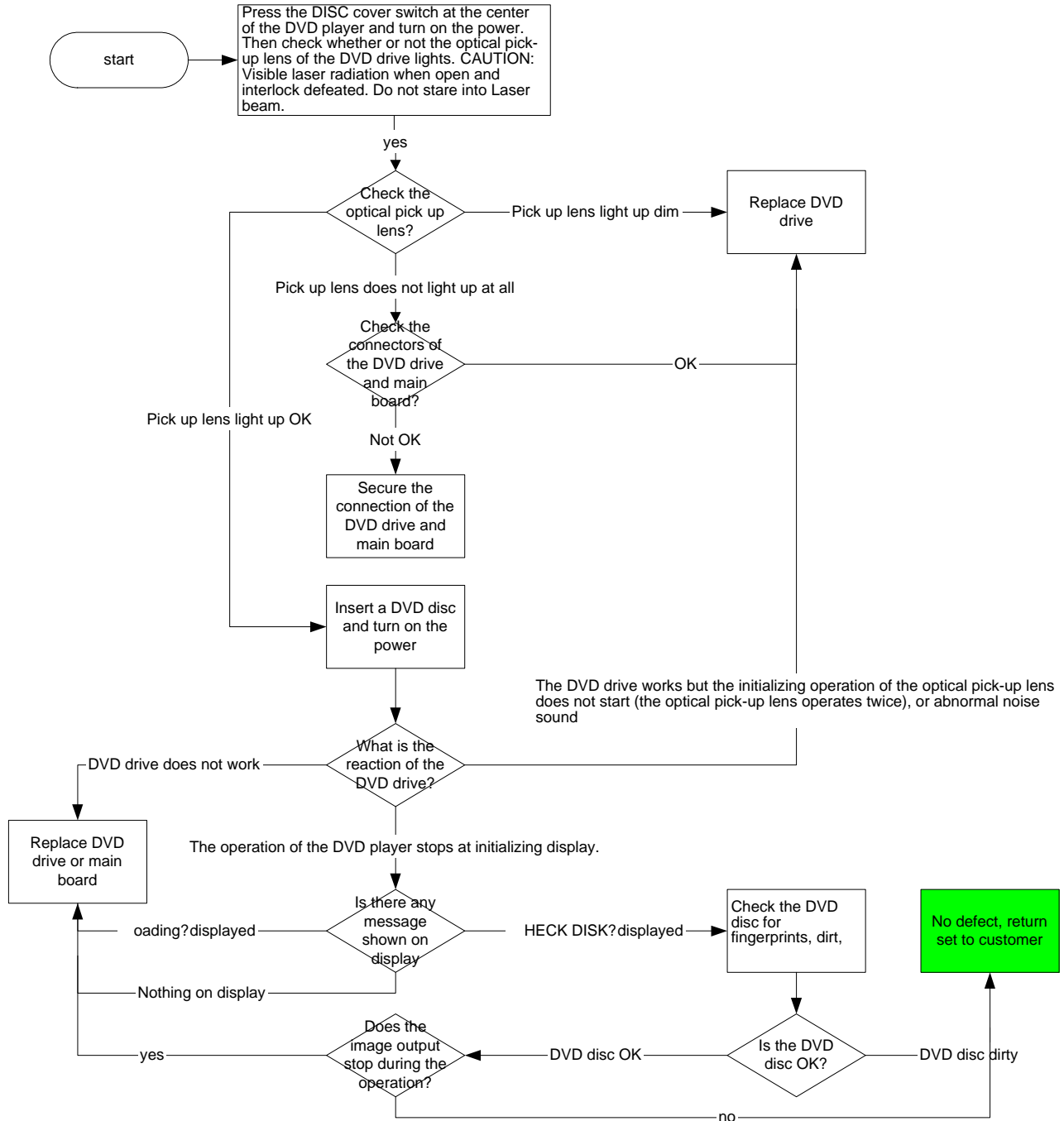

5.0 TROUBLESHOOTING & SERVICE TIPS

SYMPTOM: THE DVD DRIVE DOES NOT OPERATE WITH BATTERY

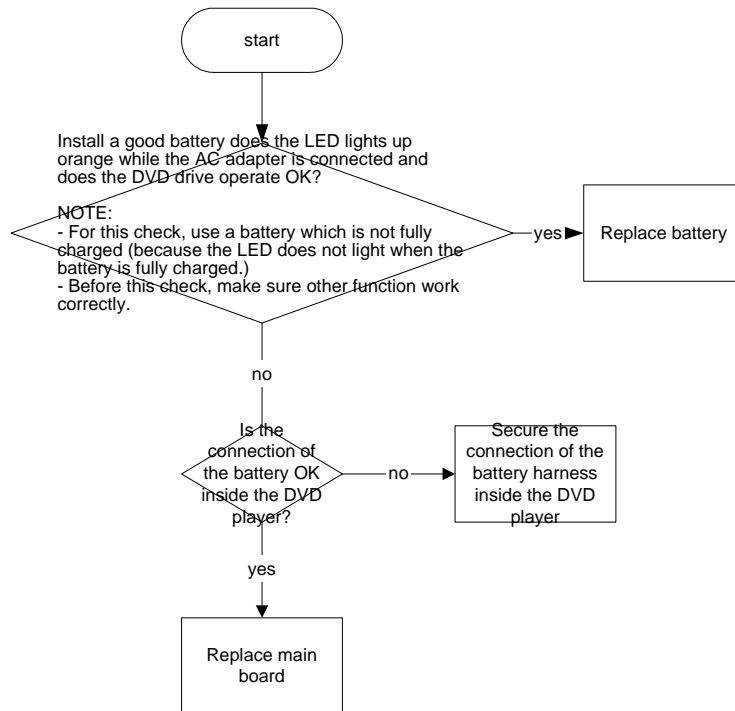

SYMPTOM: NO SOUND COMES FROM THE HEADPHONES

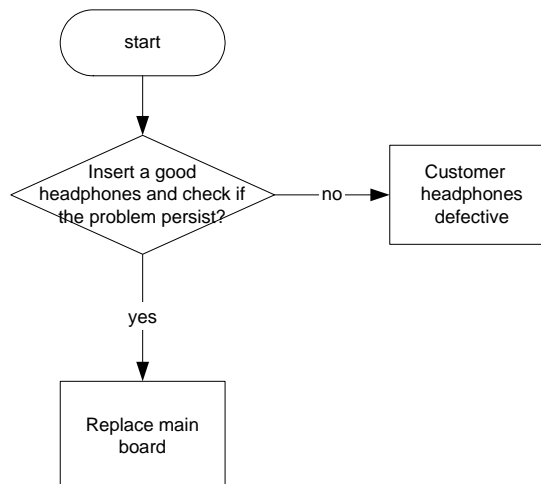

6.0 OVERALL BLOCK DIAGRAM

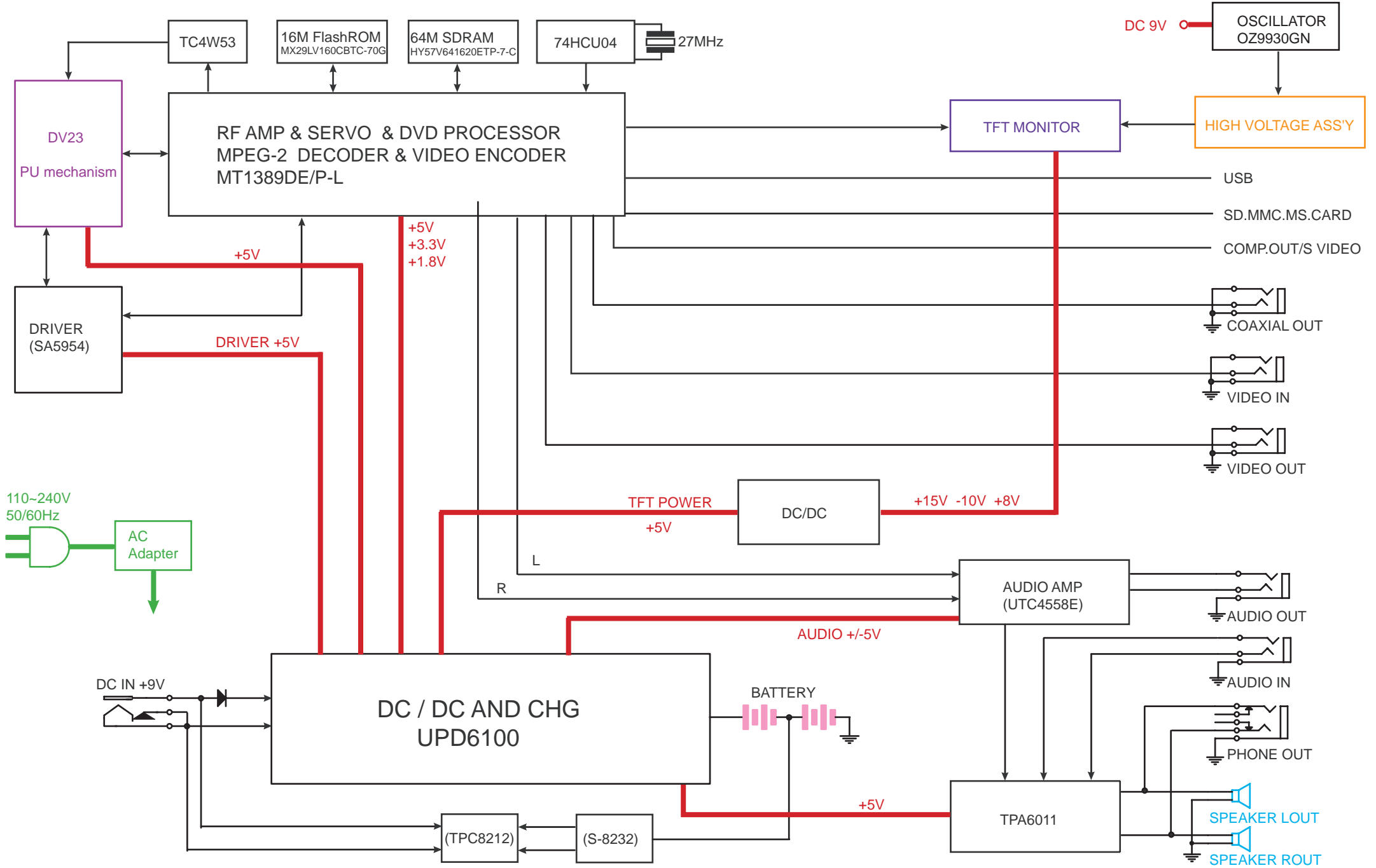

7.0 OVERALL WIRING DIAGRAM

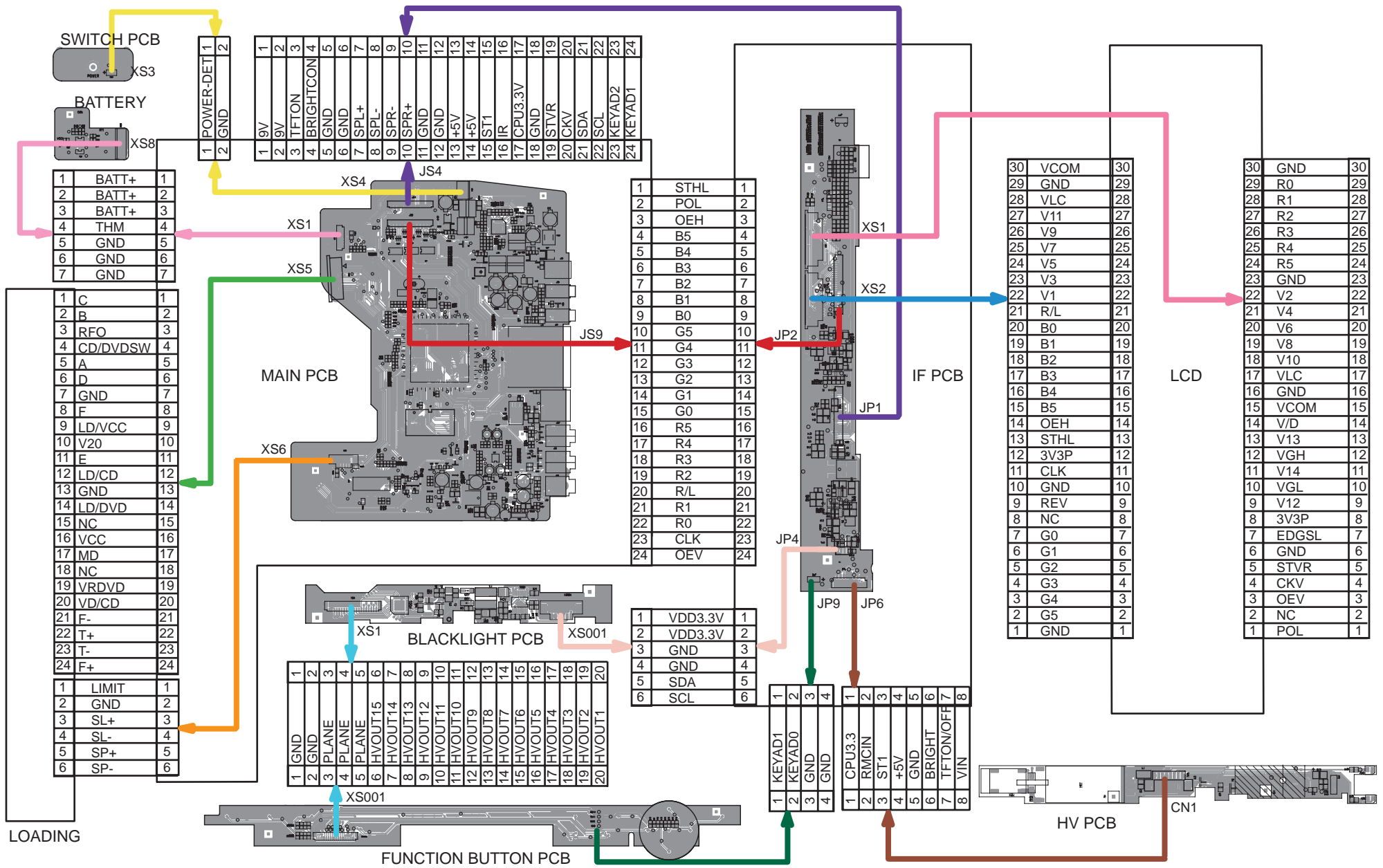

8.0 ELECTRICAL DIAGRAM MAIN BOARD CIRCUIT DIAGRAM (MT1389P)

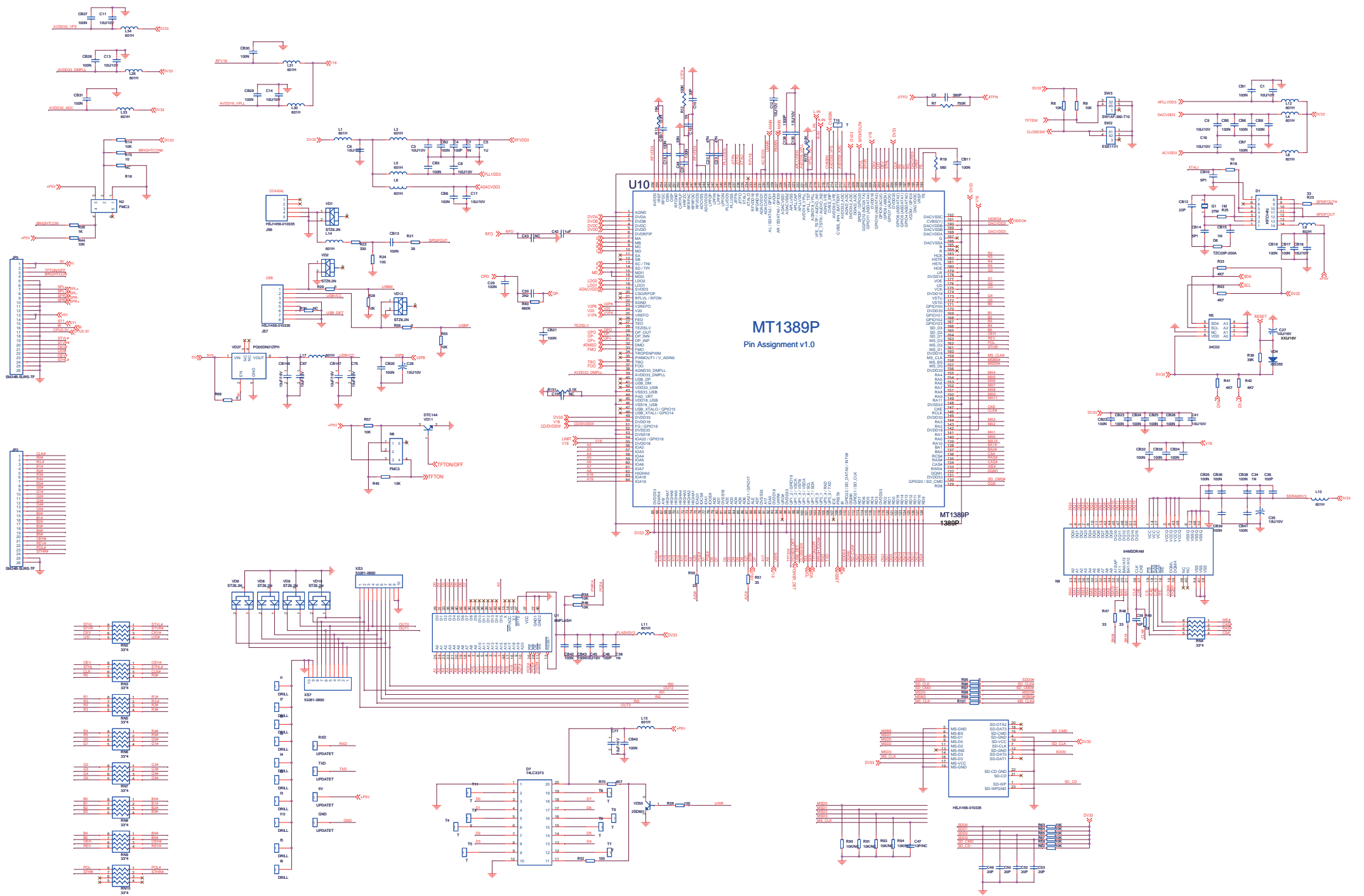

8.0 ELECTRICAL DIAGRAM MAIN BOARD CIRCUIT DIAGRAM (AUDIO)

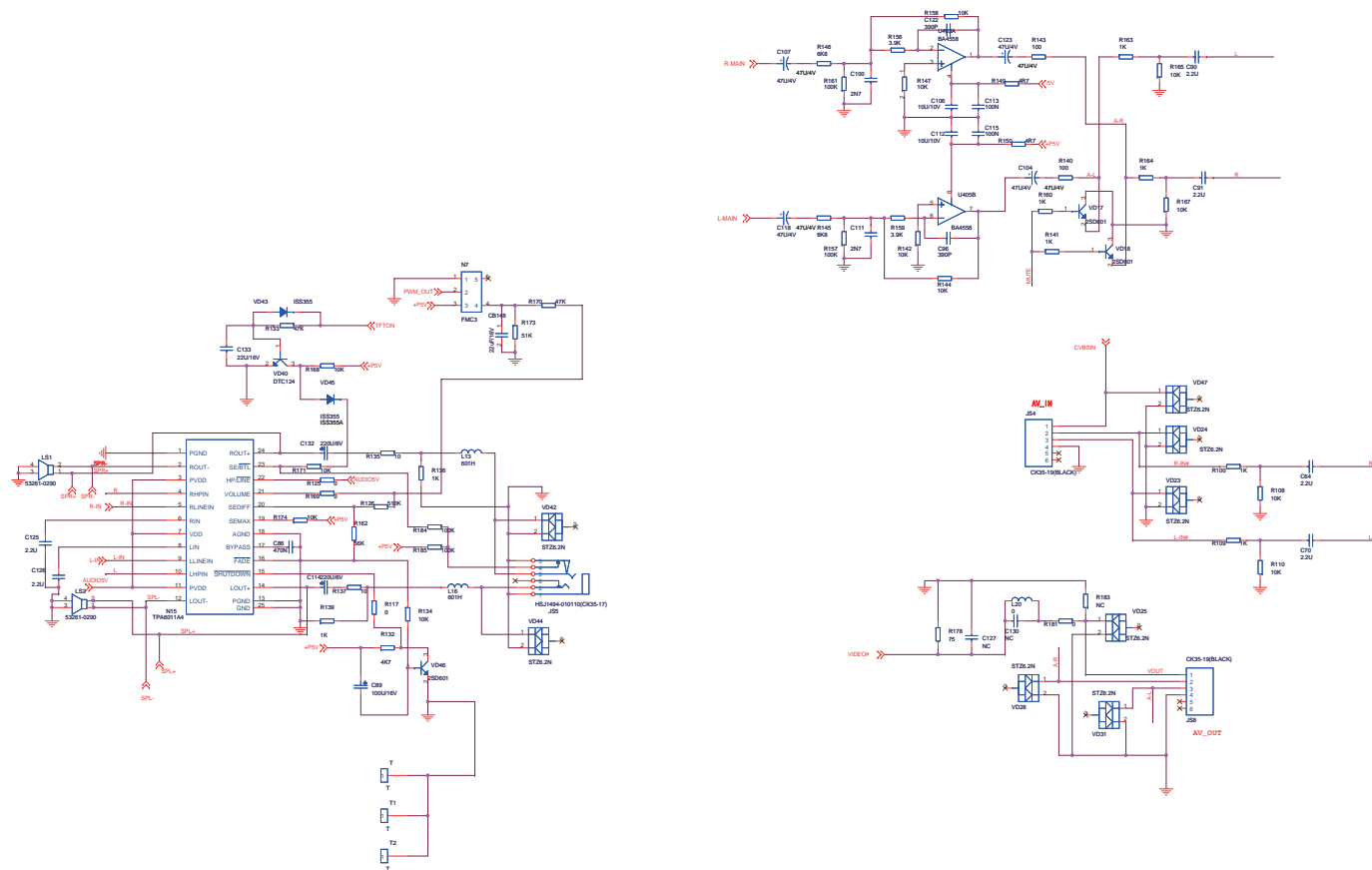

8.0 ELECTRICAL DIAGRAM MAIN BOARD CIRCUIT DIAGRAM (DRIVER)

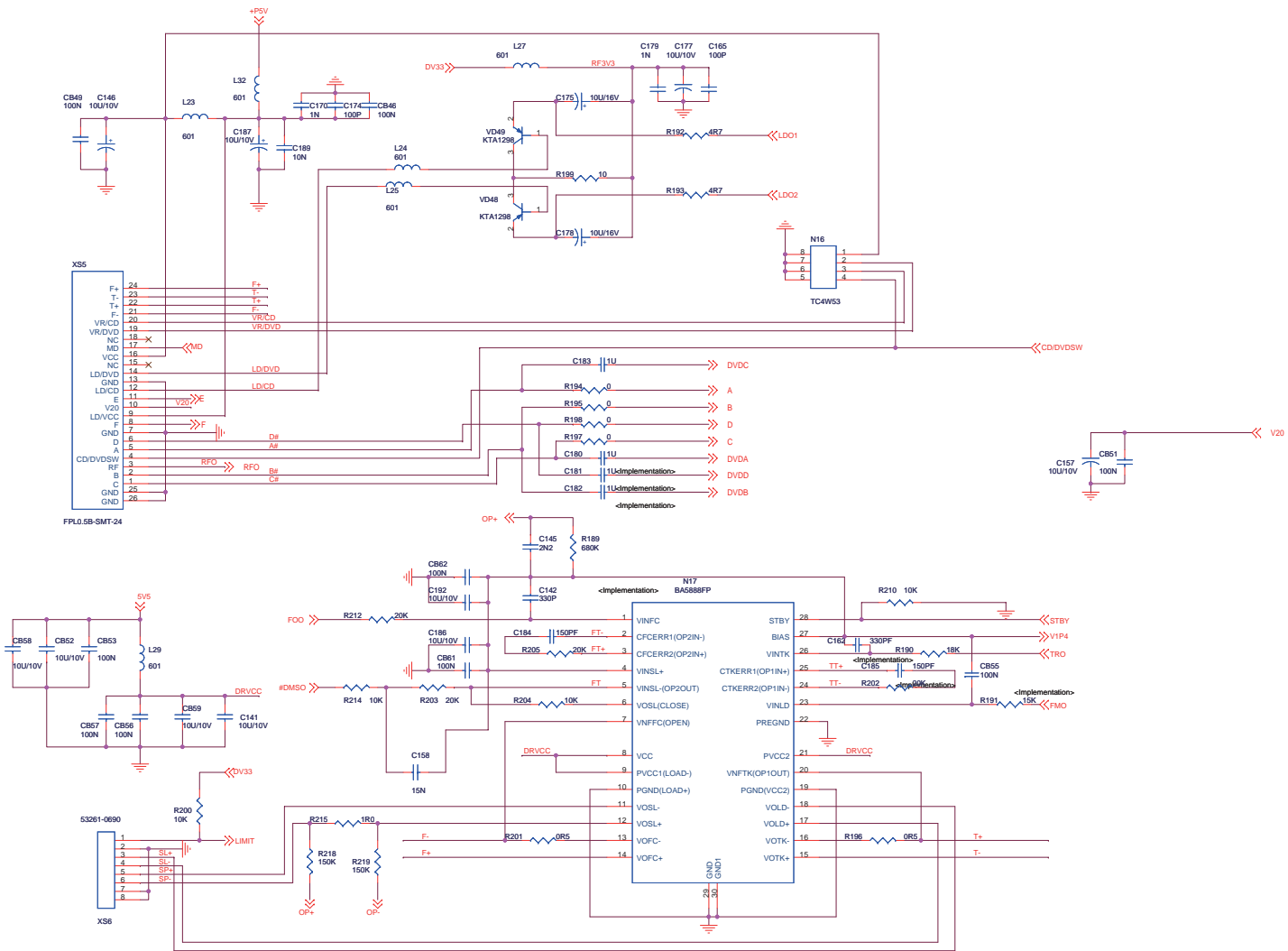

8.0 ELECTRICAL DIAGRAM MAIN BOARD CIRCUIT DIAGRAM (POWER & CHARGE)

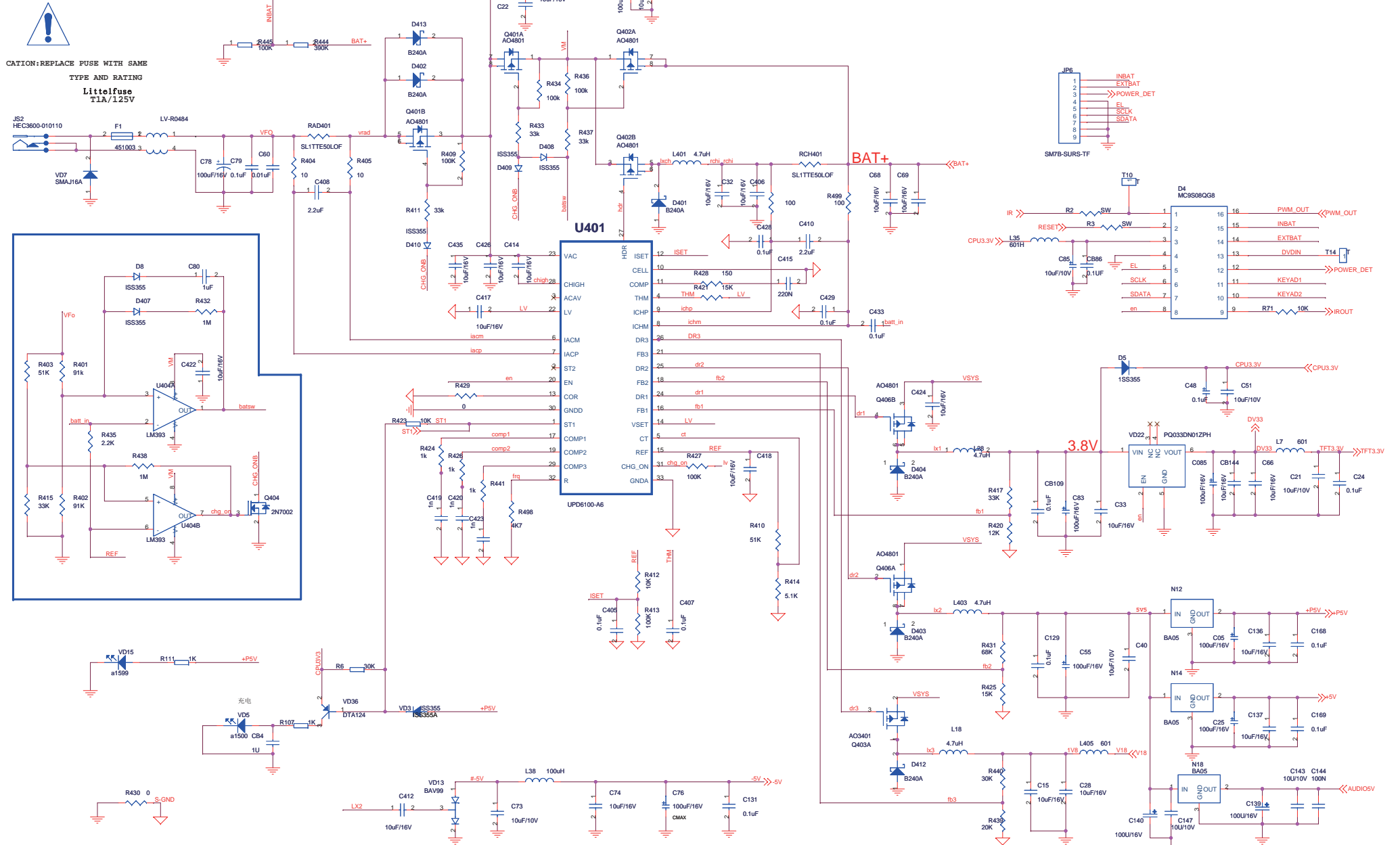

!!!!R219 was connected to ##DCIN now to VSYS

8.0 ELECTRICAL DIAGRAM HV BOARD CIRCUIT DIAGRAM

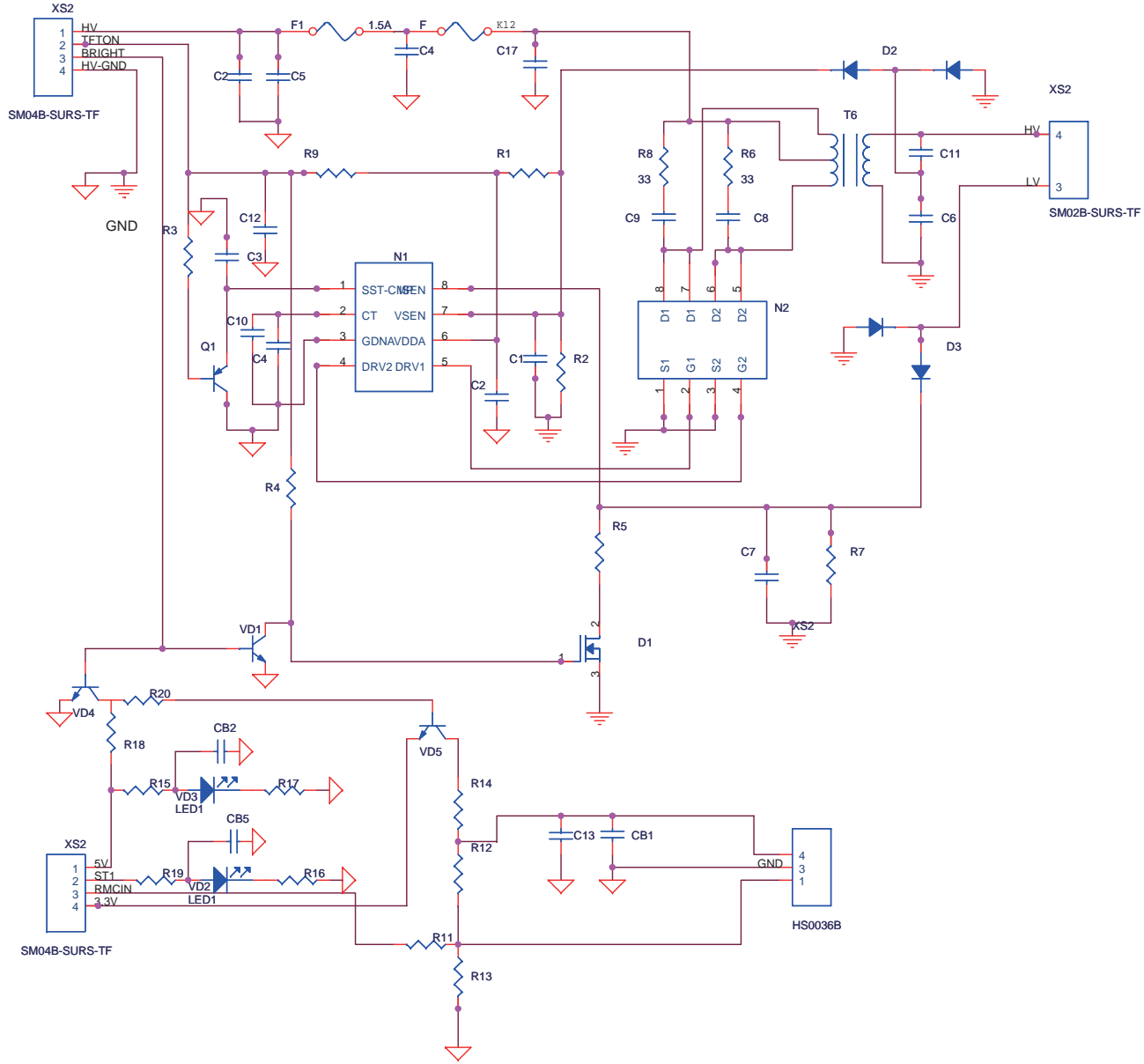

9.0 COMPONENT LAYOUT

PET1030H HV BOARD DIAGRAM

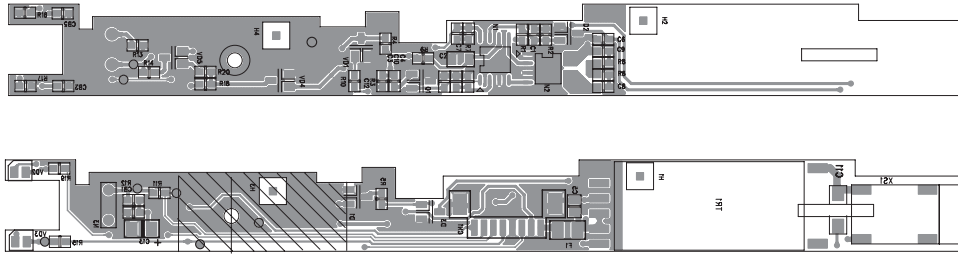

PET1030T IF BOARD DIAGRAM

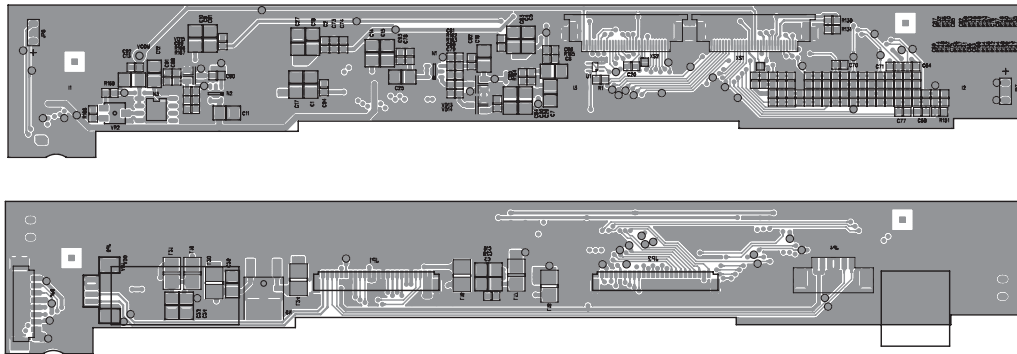

PET1030K FUNCTION BOARD DIAGRAM

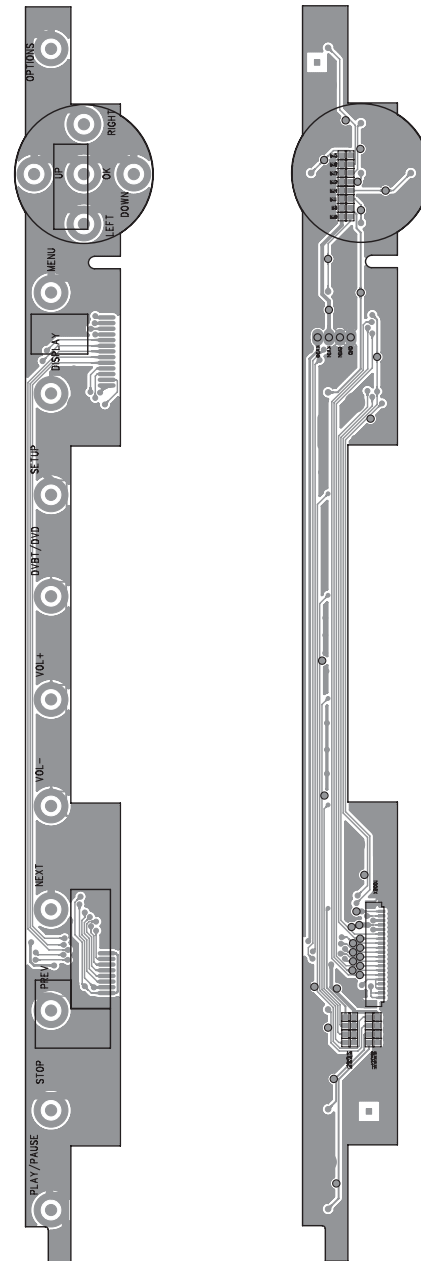

9.0 COMPONENT LAYOUT

PET1035M MAIN BOARD DIAGRAM (TOP)

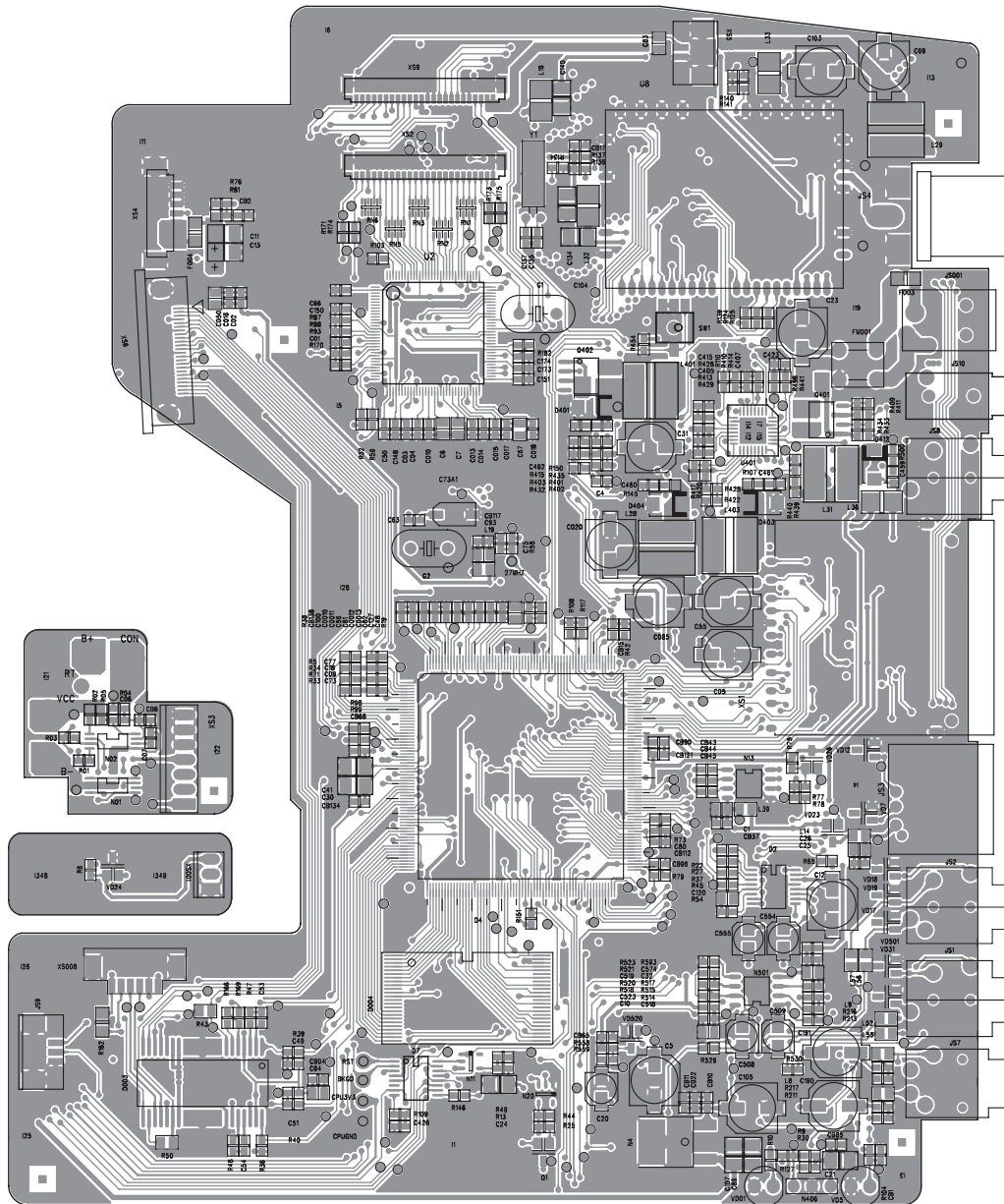

PET1035M MAIN BOARD DIAGRAM (BOTTOM)

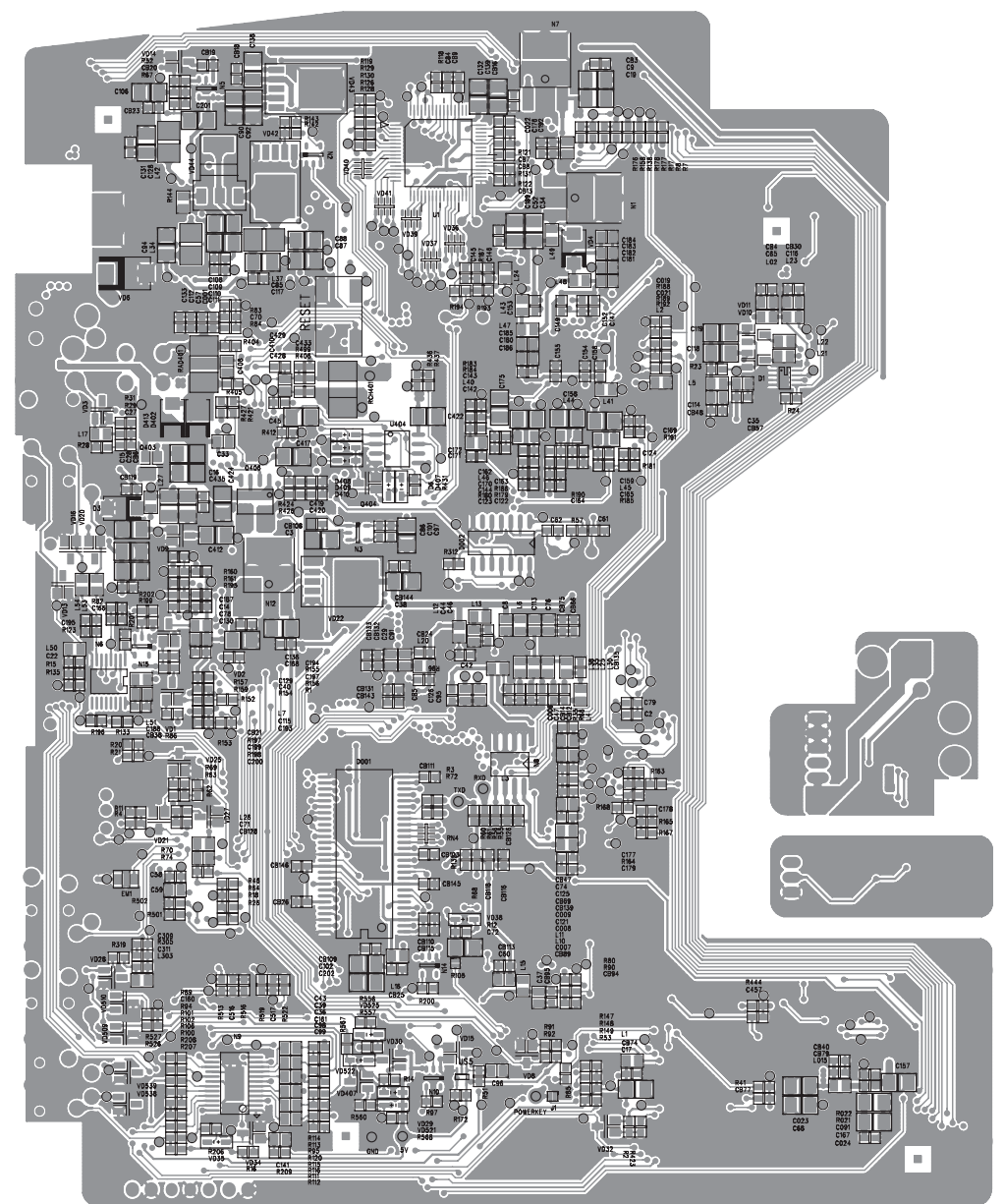

10.0 SERVICE PART LIST

Electrical Part List:

No.	CTN	Service 12NC	Service Description	Photo	Pos. No.
1	PET1030/00 PET1030/05	996510003962	PET1030M MAIN PCB ASS'Y/00/05		100
	PET1030/58	996510004976	PET1030M MAIN PCB ASS'Y/58		
	PET1030/98	996510004548	PET1030M MAIN PCB ASS'Y/98		
	PET1035/00	996510005762	PET1035M MAIN PCB ASS'Y/00		
2	PET1030 PET1035	996510003963	PET1030T IF PCB ASS'Y		110
3	PET1030 PET1035	996510003964	PET1030K FUNCTION PCB ASS'Y		120
4	PET1030 PET1035	996510003965	PET1030H HV PCB ASS'Y		130
5	PET1030 PET1035	996510001274	24 PIN HARDNESS-180-PF		141
6	PET1030	994000002241	20 PIN HARDNESS-2-PF (LE105)		142
7	PET1030 PET1035	996510003961	PET1030 LITHIUM BATTERY		150
8	PET1030 PET1035	996510006526	PET1030 BATTERY PROTECTIVE PCBA		155
9	PET1035	996510004978	PET1030EL BACKLIGHT PCB ASS'Y		160
10	PET1030 PET1035	996510005764	PET1030 POWERKEY ASSY		370



10.0 SERVICE PART LIST

Mechanical Part List:

No.	CTN	Service 12NC	Service Description	Photo	Pos. No.
11	PET1030 PET1035	994000002163	A102VW01 TFT LCD		200
12	PET1030 PET1035	996510004977	DV23FC LOADING ASS'Y		210
13	PET1030 PET1035	994000002165	YD1635-2 SPEAKER		220
14	PET1030 PET1035	996510003967	TOP COVER PET1030		300
15	PET1030 PET1035	996510003968	DISPLAY FRAME PET1030		310
16	PET1030 PET1035	996510003969	DOOR + MIDDLE CABINET PET1030		320
17	PET1030	996510003970	BASE COVER PET1030		330
	PET1035	996510005763	BASE COVER PET1035		

10.0 SERVICE PART LIST

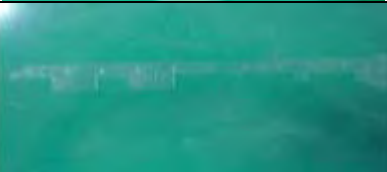
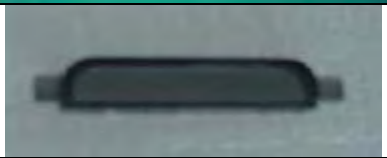
Mechanical Part List:

No.	CTN	Service 12NC	Service Description	Photo	Pos. No.
18	PET1030 PET1035	996510003972	ADJUST HINGE PET1030	 A silver metal hinge component with a central cross-shaped hole and two mounting tabs on either side, set against a green background.	340
19	PET1030 PET1035	996510003971	FUNCTION BUTTON PC PET1030	 A small, rectangular, light-colored button component with a central circular feature, set against a green background.	350
20	PET1030 PET1035	996510003973	LENS REMOTE SENSOR PET1030	 A black, elongated, rectangular sensor component with a central lens area, set against a grey background.	360
21	PET1030 PET1035	996510006727	BASE COVER ADORN DISCRETENESS	 A long, thin, silver-colored decorative trim piece with a central rectangular cutout, set against a grey background.	380
22	PET1030 PET1035	996510006728	PET1030 SPEAKER SKILL	 A black speaker component with a circular driver and a rectangular grille, set against a grey background.	390

10.0 SERVICE PART LIST

Accessories Part List:

No.	CTN	Service 12NC	Service Description	Photo	Pos. No.
23	PET1030/00 PET1030/58 PET1030/98 PET1035/00	994000003946	ADPV26A AC POWER ADAPTOR/00		ACADAPTOR
	PET1030/05	996510003966	ADPV26A AC POWER ADAPTOR/05		
	PET1030/37	996510001403	ADPV26A AC POWER ADAPTOR/37		
	PET1030/93	996500042048	ADPV26A AC POWER ADAPTOR/93		
24	PET1030 PET1035	996510001124	CAR CIGARETTE ADAPTER		CARADAPTOR
25	PET1030 PET1035	994000001912	AV CABLE		AVCABLE
26	PET1030 PET1035	994000002586	DVD960 S- VIDEO CABLE		SCABLE
27	PET1030	996510001287	RC-AY5507 REMOTE CONTROL		RC
	PET1035	996510003009	PRC500-20 REMOTE CONTROL		
28	PET1030 PET1035	996510001130	CAR MOUNT AY4246		CARMOUNT

11.0 REVISION LIST

Version 1.0 (3141 785 31730)

- Initial release PET1030/00/05

Version 1.1 (3141 785 31731)

- Update content with PET1030/37/58/93/98

Version 1.2 (3141 785 31732)

- Update content with PET1035/00
- Add new part PET1030 POWERKEY ASSY 12NC is 996510005764
- Replace battery 12NC from 996510003961 to 996510005903

Version 1.3 (3141 785 31733)

- Add new part 996510006727 & 996510006728
- Update section 4, disassembly procedure